

F-tone Networks 40KM SFP+ ER Optical Transceiver

- ◆ Compliant with SFF-8431 and IEE802.3ae
 - ◆ Supports rate up to 10.3 Gb/s bit rates
 - ◆ 1G/2G/4G/ 8G/10G Fiber Channel applications.
 - ◆ Data rate selectable $\leq 4.25\text{Gbps}$ or 9.95Gbps to 10.3Gbps bit rates
 - ◆ Cooled EML transmitter and PIN receiver
 - ◆ link length up to 40km
 - ◆ Low Power Dissipation 1.5W Maximum
 - ◆ Single 3.3V power supply
 - ◆ Diagnostic Performance Monitoring of module temperature, supply Voltages, laser bias current, transmit optical power, receive optical power
 - ◆ For the OBSAI application, the rates are 6.144Gb/s, 3.072 Gb/s, 1.536 Gb/s and 0.768 Gb/s.
 - ◆ For the CPRI application, the rates are 6.144Gb/s, 3.072 Gb/s, 2.4576 Gb/s, 1.2288 Gb/s, 0.6144 Gb/s.
 - ◆ RoHS compliant and lead free 
 - ◆ Operating case temperature:
 - Standard : 0 to +70°C
 - Industrial : -40 to +85°C
-
- ◆ 10GBASE-ER/EW (with/without FEC)
 - ◆ 10G Fiber Channel (with/without FEC)
 - ◆ For the OBSAI application, the rates are 6.144Gb/s, 3.072 Gb/s, 1.536 Gb/s and 0.768 Gb/s.
 - ◆ For the CPRI application, the rates are 6.144Gb/s, 3.072 Gb/s, 2.4576 Gb/s, 1.2288 Gb/s, 0.6144 Gb/s.
 - ◆ 1G/2G/4G/ 8G/10G Fiber Channel applications.

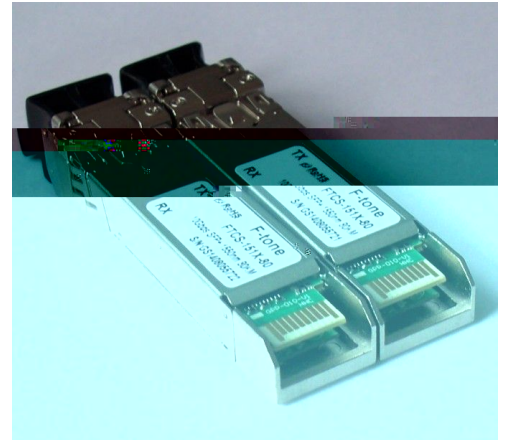

F-tone Networks SFP+ER Transceiver is designed for 10GBASE-ER/EW, and 8.5G/10G Fiber-Channel applications.

The transceiver consists of two sections: The transmitter section incorporates a colded EML laser. And the receiver section consists of a PIN photodiode integrated with a TIA. All modules satisfy class I laser safety requirements. F-tone Networks SFP+ER Digital diagnostics functions are available via a 2-wire serial interface, as specified in SFF-8472, which allows real-time access to device operating parameters such as transceiver temperature, laser bias current, transmitted optical power, received optical power and transceiver supply voltage.

| Supply Voltage | Vcc | -0.5 | 3.8 | V |
|---------------------|-----|------|-----|----|
| Storage Temperature | Tst | -40 | 85 | °C |
| Relative Humidity | Rh | 0 | 85 | % |

| Supply Voltage | Vcc | 3.13 | 3.3 | 3.47 | V |
|----------------------------|-----|------|-----|------|----|
| Supply current | Icc | | 360 | 450 | mA |
| Operating Case temperature | Tca | -5 | - | 70 | °C |
| Module Power Dissipation | Pm | - | 1.2 | 1.5 | W |

[1] Supply current is shared between VCCTX and VCCR. X.

[2] In-rush is defined as current level above steady state current requirements.

| Center Wavelength | | 1530 | | 1565 | nm |
|-----------------------------------|-------------|------|---|------|-------|
| Optical Average Power | Po | 0 | - | +3 | dBm |
| Optical OMA Power | Pom | -2.1 | | | dBm |
| Side Mode Suppression Ratio | SMSR | 30 | - | - | dB |
| Optical Transmit Power (disabled) | PTX_DISABLE | - | - | -30 | dBm |
| Extinction Ratio | ER | 8.2 | | - | dB |
| RIN _{21OMA} [1] | | | | -128 | dB/Hz |
| Optical Return Loss Tolerance | | | | 21 | dB |

[1] RIN measurement is made with a return loss at 21 dB.

| Data Rate | Mra | - | 10.3 | 11.3 | Gbps |
|-----------|-----|---|------|------|------|

| | | | | | |
|------------------------------|---------|-----|-----|----------|----|
| Input differential impedance | Rim | - | 100 | - | Ω |
| Differential data Input | VtxDIFF | 120 | - | 850 | mV |
| Transmit Disable Voltage | VD | 2.0 | - | Vcc3+0.3 | V |
| Transmit Enable Voltage | Ven | 0 | - | +0.8 | V |
| Transmit Disable Assert Time | Vn | - | - | 100 | us |

| | | | | | |
|---|-------------|------|---|-------|-----|
| Input Operating Wavelength | | 1530 | - | 1565 | nm |
| Average receive power | | - | - | -1.0 | dBm |
| Receiver sensitivity in OMA | | - | - | -14.1 | dBm |
| Stressed receiver sensitivity in OMA[1] | | | | -11.3 | dBm |
| Maximum Input Power | RX-overload | - | - | -1 | dBm |
| Reflectance | Rrx | - | - | -27 | dB |
| Loss of Signal Asserted | | -25 | - | - | dBm |
| LOS De-Asserted | | - | - | -16 | dBm |
| LOS Hysteresis | | 0.5 | - | - | dB |

[1] Measured with conformance test signal for BER = 10^{-12} . The stressed sensitivity values in the table are for system level BER measurements which include the effects of CDR circuits. It is recommended that at least 0.4 dB additional margin be allocated if component level measurements are made without the effects of CDR circuits.

| | | | | | |
|---------------------------|----------|-----|------|-----------|------|
| Data Rate | Mra | - | 10.3 | 11.3 | Gbps |
| Differential Output Swing | Vout P-P | 350 | - | 850 | mV |
| Rise/Fall Time | Tr / Tf | 24 | - | - | ps |
| Loss of Signal –Asserted | VOH | 2 | - | Vcc3+0.3- | V |
| Loss of Signal –Negated | VOL | 0 | - | +0.4 | V |

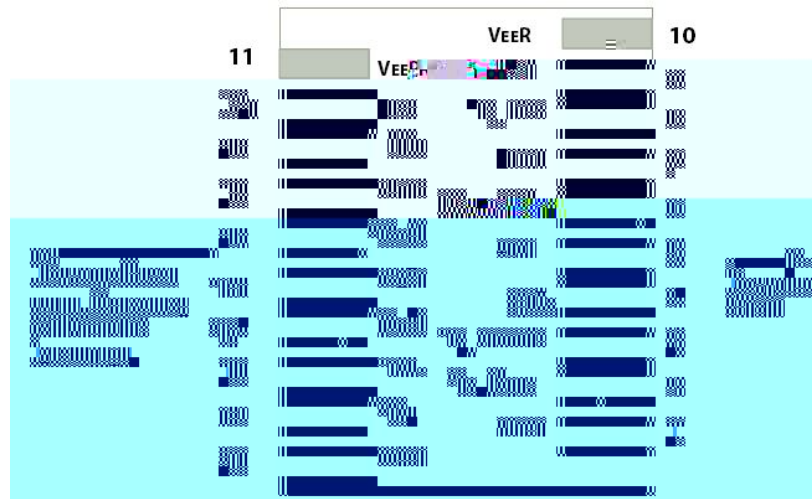

| | | |
|----|--------------|---|
| 1 | VEET [1] | Transmitter Ground |
| 2 | Tx_FAULT [2] | Transmitter Fault |
| 3 | Tx_DIS [3] | Transmitter Disable. Laser output disabled on high or open |
| 4 | SDA [2] | 2-wire Serial Interface Data Line |
| 5 | SCL [2] | 2-wire Serial Interface Clock Line |
| 6 | MOD_ABS [4] | Module Absent. Grounded within the module |
| 7 | RS0 [5] | RS0 for Rate Select: Open or Low = Module supports ≤ 4.25 Gbps High = Module supports 9.95 Gb/s to 10.3125 Gb/s |
| 8 | RX_LOS [2] | Loss of Signal indication. Logic 0 indicates normal operation |
| 9 | RS1 [5] | No connection required |
| 10 | VEER [1] | |



| | | |
|----|----------|--|
| 18 | TD+ | Transmitter DATA in. AC Coupled |
| 19 | TD- | Transmitter Inverted DATA in. AC Coupled |
| 20 | VEET [1] | Transmitter Ground |

[1] Module circuit ground is isolated from module chassis ground within the module.

[2].should be pulled up with 4.7k – 10k ohms on host board to a voltage between 3.15V and 3.6V.

[3]Tx_Disable is an input contact with a 4.7 k to 10 k pullup to VccT inside the module.

[4]Mod_ABS is connected to VeeT or VeeR in the SFP+ module. The host may pull this contact up to Vcc_Host with a resistor in the range 4.7 k to 10 k .Mod_ABS is asserted “High” when the SFP+ module is physically absent from a host slot.

[5] RS0 and RS1 are module inputs and are

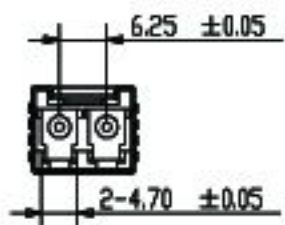
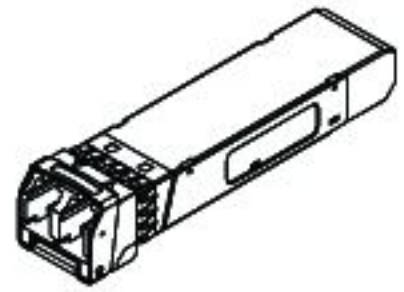
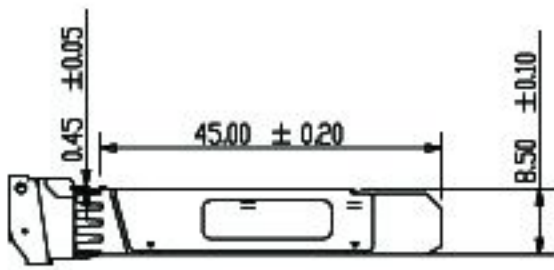
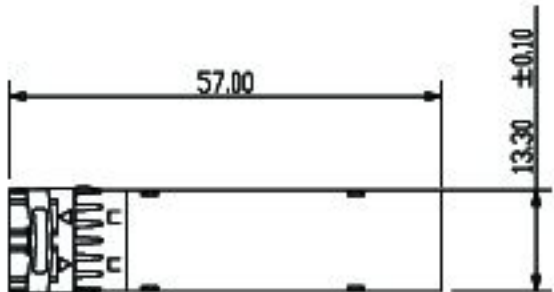
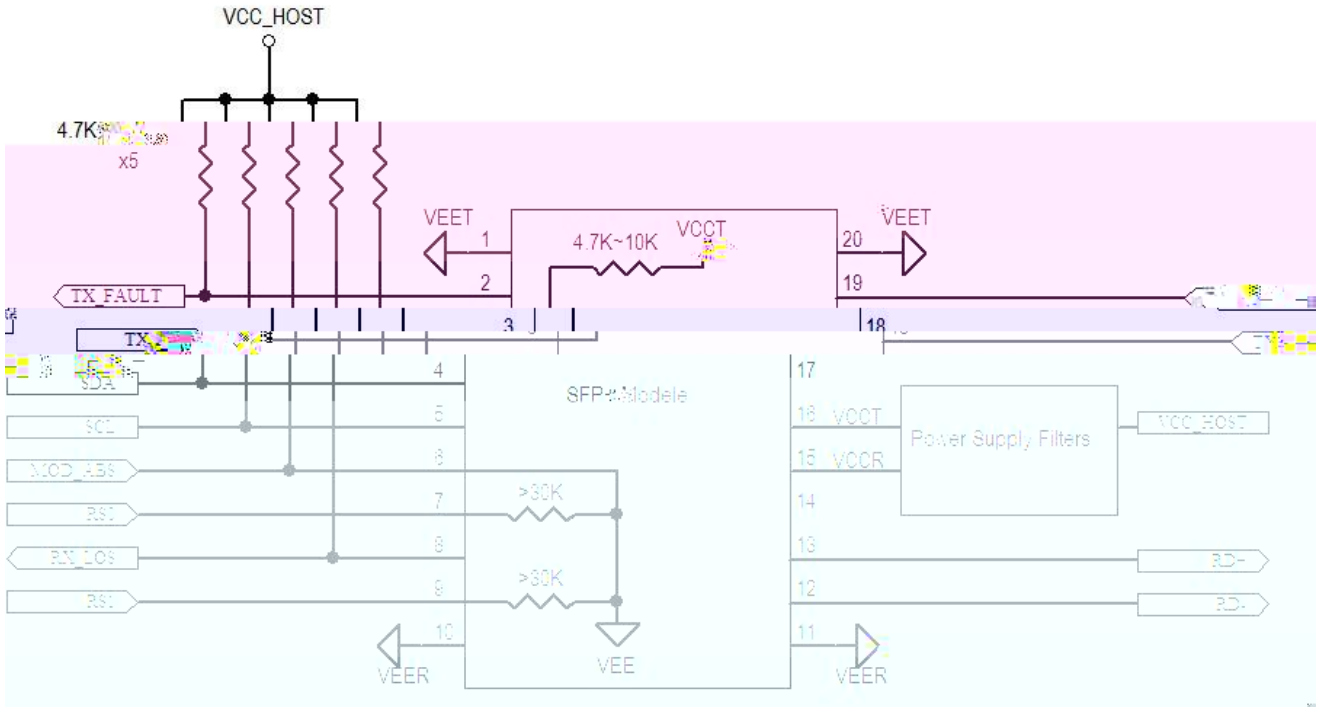



F-tone Networks SFP+ transceiver is designed to be Class I

ser